

# W&C WELLING & CROSSLEY

## Generator Operation Manual

WC-P8750 - 811626



## 1. Introduction

Congratulations on your purchase of a Welling and Crossley AVR Generator with E-start.

Supplied with transport kit (handles and wheels), this generator is Euro 5 emissions compliant. The generously sized fuel tank and economical motor allows longer run-times. Your WC-P8750 packs a lot of power in a compact footprint.





**Please read this manual carefully before operating as it provides information regarding the operation and maintenance of your generator to ensure reliable operation.**

## 2. Construction and Key Features

- 2 x Outlets (single phase - 15 Amp)
- USB A and USB C outlets
- Weather resistant outlets (IP66)
- Recoil, Push-button electric, Wireless remote or 2 wire remote starting
- Steel frame with large wheels
- Fold-out wheelbarrow style transport handle
- 4-Stroke, air cooled, OHV engine
- Large 25L fuel tank
- Digital V/F/T Display (Volts, Frequency, Time)
- Low oil alarm, overload alarm, output indicator
- 2 year Welling and Crossley Warranty (*battery excluded*)

## 3. Important icons

The design and manufacture of your WC-P8750 Generator places a premium on the safety of the user. However, due to the combination of a highly flammable fuel source (petrol), heat from the engine and high electrical voltage output, due care and attention must be taken at all times. **These icons will be used throughout the manual.**

	Warning - Electrical safety.
	Danger – Potential consequences of use outside of intended application(s). Includes environmental condition warnings.
	Warning / Caution: - Indicates a hazardous situation which, if not strictly complied with, may result in property damage.
	Read carefully. This important information will simplify operation and aid understanding.

## 4. Contents

1. Introduction.....	2
2. Construction and Key Features.....	2
3. Important icons.....	2
4. Contents.....	3
5. Generator Specifications.....	6
6. Warnings.....	7
7. Operators Checklist.....	9
8. Getting Started.....	10
8a. Attach the battery wire.....	10
8b. Check the engine Oil.....	10
8c. Check the Fuel Level.....	11
8d. Safe Fuel Handling.....	11
8e. Starting the generator.....	12
8f. Maximum electrical capacity.....	13
8g. Stopping the generator.....	13
9. Maintenance.....	14
9a. Air Filter.....	15
9b. Spark Plug.....	15
9c. Cleaning.....	15
10. Storage and Transportation.....	16
11. Trouble Shooting Guide.....	17
12. Warranties – Terms and Conditions.....	18





**ENGINE SHIPPED WITHOUT ENGINE OIL**



Take a moment to fill engine with engine oil to the upper mark on the dipstick.

**DO NOT OVERFILL**



Check level and read Operator's Manual before proceeding.

Fuel Filler and Fuel Gauge

Recoil pull starter



Air filter – Service every 25 hrs

Digital Display  
Voltage / Hertz / Run Hours

Engine Switch

Electric Start

AC circuit breaker

2 x 15A IP66 outlets

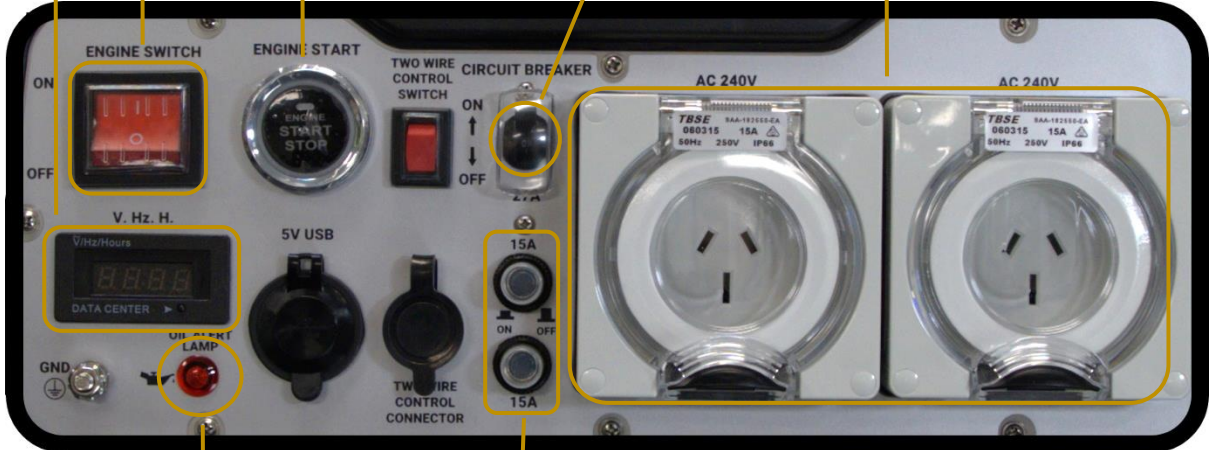

Low oil level warning  
**Note: Generator will NOT start when oil level is low**

AC resettable overloads





Oil Drain  
**1<sup>st</sup> oil change after 5 hours.**  
**Thereafter every 20 hours**

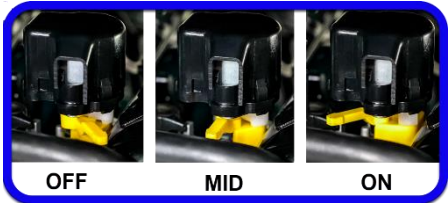

Spark Plug  
**Replace Yearly**

Auto Choke

25L fuel tank







Take care not to splash water in this area

## 5. Generator Specifications

Model	WC P8750
Alternator Rating	8.75kVa with AVR (Automatic Voltage Regulation)
Power Factor	1.0
Max. AC Output	7000W
Rated AC Output	6800W
Rated motor speed	3000 rpm
Rated Voltage	240/230V AC Single Phase
Engine Model	WC-420: Euro 5 emissions compliant
Engine Type	4 stroke, OHV, air cooled. Transistor ignition
Displacement	420cc
Fuel Type	Petrol – 91 octane unleaded. < 1500m - 95 octane is recommended
Fuel Tank Capacity	25L
Fuel Consumption	1.48 L/Hr @ 1/4 load
Continuous Operation	Maximum 16.9 hrs @ ¼ load
Oil	SAE10W-30. > 40deg C use SAE30W
Decibels @ 7m distance	99 dBA
Dimensions and weight	L: 700mm W: 660mm H: 660mm 90kg
Packaging (LxWxH)	710 x 535 x 590mm
Engine Starting	Recoil or Electric start Push Button and/or wireless remote start. 2 wire remote start function
Electric Start Battery	12V, 18A/hr
Electrical Outlets (230V)	2 x IP66, Type I, 15 Amp 3 pin sockets 1 x USB Type A (18W) 1 x USB Type C (15W)

## 6. Warnings

   	<p>Read the manual carefully before starting and retain for future reference. <b>DO NOT</b> Operate this generator until you have read <b>ALL</b> safety, operation, and maintenance instructions.</p>
	<p>The warnings and precautions discussed in this manual cannot cover all possible conditions and situations that may occur. It must be understood by the operator that common sense and caution are factors which cannot be built into this product but must be supplied by the operator.</p>
	<p>Failure to follow the instructions may result in property damage, <b>INJURY</b> or <b>DEATH</b>.</p>
	<p>This appliance is not intended for use by persons (including children) with reduced physical, sensory or mental capabilities, or lack of experience and knowledge, unless they have been given supervision or instruction concerning use of the appliance by a person responsible for their safety. Children should be supervised to ensure that they do not play with the appliance.</p>

Before use, check for loose or damaged parts, signs of oil or fuel leaks, and any other condition that may affect proper operation. Repair or replace all damaged or defective parts immediately.

- Locate all operating controls and safety labels.
- Operate only on level surfaces.
- Protect generator from excessive moisture, dust, or dirt.
- Ensure all safety guards are always in place and in proper working order.
- **DO NOT** allow any material to block the cooling slots.
- Never allow the generator to run unattended.
- Turn off the generator before leaving the area.

### **DANGER: TOXIC FUMES:**



The exhaust of the generator engine contains carbon monoxide, an odorless, colourless, poison gas. Running an engine indoors may cause death.

- NEVER use generator inside any building or any kind of enclosure, **EVEN IF** doors and windows are open.
- Place the generator in a well-ventilated area and consider wind strength and air flow when positioning the generator.



### **DANGER: MOVING PARTS:**



Moving parts can cause severe injury. Keep hands and feet away.

- **DO NOT** operate generator with covers, shrouds, or guards removed.
- **DO NOT** wear loose-fitting clothing, dangling drawstrings or items that could become caught. Tie up long hair and remove jewellery.



**DANGER: FIRE OR EXPLOSION:**



Petrol is highly flammable and extremely explosive.

- Fire or explosion can cause severe burns or death.
- Keep flammable items away while handling gasoline.
- Keep fire extinguisher handy and be prepared if a fire starts.
- Use proper fuel storage and handling procedures. DO NOT store fuel or other flammable materials nearby.
- Fill fuel tank outdoors and in a well-ventilated area with the generator stopped.
- Avoid overfilling the fuel tank. Leave a 25mm air gap to allow for heat expansion.
- Always wipe off spilled fuel and wait until the fuel has dried before starting the generator.
- Empty the fuel tank before storing or transporting the generator.
- NEVER operate the generator with known leaks in the fuel system.



**WARNING: HOT SURFACE:**



The running generator produces heat. Severe burns can occur on contact.

- DO NOT touch generator while operating or just after stopping. Avoid contact with hot exhaust gases.
- Maintain at least three feet of clearance on all sides to ensure adequate cooling.
- Combustible material can catch fire on contact. Maintain at least one metre of clearance from any combustible materials.



**WARNING: ELECTRICAL SHOCK:**



This generator produces powerful voltage and the electricity CAN KILL YOU.

- To reduce the risk of electrical shock, DO NOT use electrical cords that are worn, frayed, bare or otherwise damaged.
- DO NOT touch bare wires or receptacles.
- DO NOT operate the generator while directly exposed to wet weather. Keep the generator dry.
- DO NOT handle generator or electrical cords while standing in water, while barefoot, or while hands or feet are wet.





## 7. Operators Checklist

**OPERATING AREA** - This generator is intended for outdoor use.



- Only use OUTSIDE and place the generator in a well-ventilated area.
- Only operate the generator on a flat, level surface and in a clean, dry operating environment.
- Allow one metre clearance on all side of the generator while operating it outdoors.
- Generators used for construction sites may be subject to additional rules and regulations.

**DANGER: TOXIC FUMES** - The exhaust of the generating set contains carbon monoxide, an odorless, colourless, poison gas. Using engine indoors CAN KILL YOU.

- NEVER use inside any building or any kind of enclosure, EVEN IF doors and windows are open.
- Place the generator in a well-ventilated area and carefully consider wind and air currents when positioning generator.



**OPERATING CONDITION** - Check for loose or damaged parts, signs of oil or fuel leaks, and any other condition that may affect proper operation. Repair or replace all damaged or defective parts immediately.

- Remove any excessive dirt or debris, especially around the muffler and recoil starter.
- DO NOT move or tip the generator during operation. Use generator only for intended uses. If you have questions about intended use, ask your local dealer.

**DANGER:** Failing to correct problem(s) before operation could result in property damage, serious injury or DEATH.



## 8. Getting Started

DO NOT Operate this generator until you have read ALL safety, operation, and maintenance Instructions listed in this manual.



UNPACKING –

- Remove the generator from the shipping carton.
- Place the shipping carton on a solid, flat surface.
- Carefully cut each corner of the carton box from top to bottom.
- Fold each side flat on the ground.



### 8a. Attach the battery wire

The sealed battery on the generator is fully charged and pre-installed except for the negative (black) battery cable.

1. Cut off tie wrap securing loose end of negative (black) cable.
2. Connect the negative (black) battery cable to the negative (-) terminal on the battery.
3. Secure the connections between the battery and generator.

Positive (+) terminal (red)  
Negative (-) terminal (black)

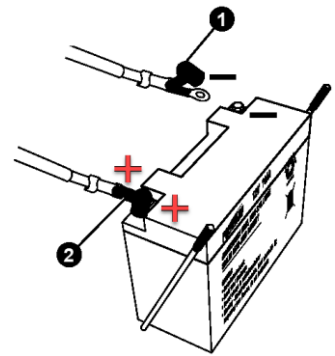

### 8b. Check the engine Oil

**WARNING:** This engine is not filled with oil from the factory. Any attempt to crank or start the engine before it has been properly filled (with the recommended type and amount of oil) may result in engine damage and void your warranty.



Place the generator on a level surface with engine stopped.

- Remove the dipstick and wipe it clean.
- Reinstall dipstick into tube; rest on oil fill neck, DO NOT thread cap into tube.
- Remove the dipstick again and check oil level. Level should be at top of indicator on dipstick.
- If the level is below or near the lower limit, fill to the upper limit (marked with “H”) of the dipstick with the recommended oil. Reinsert and fully tighten the dipstick.

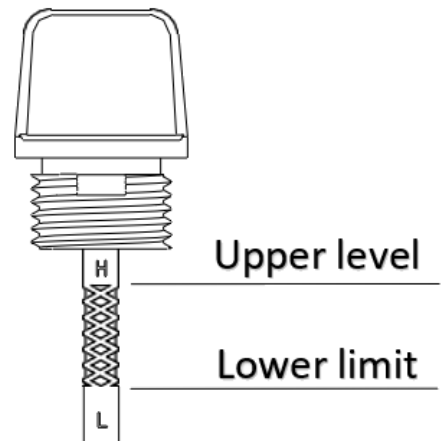

Oil is a major factor affecting performance and service life of an engine. Use 4-stroke automotive oil SAE10W-30. **Regular oil changes will extend the life of your generator.**

**LEVEL GROUND** - Operate generator only on level surface. The engine is equipped with a low oil sensor that will automatically stop the engine when the oil level falls below the safe limit. To avoid the inconvenience of an unexpected shutdown, fill to the upper limit and check the oil level regularly.



### 8c. Check the Fuel Level

CAUTION: Pressure can build up in the fuel tank.

Allow the generator to cool for at least two minutes before removing fuel cap. Loosen the fuel cap slowly to relieve any pressure in the tank.

With the engine stopped, check the fuel level gauge. Refill the fuel tank if necessary.

- Use clean, fresh, unleaded petrol only. 91 Octane
- DO NOT add oil to the petrol. The engine is a 4 stroke and does not need pre-mix.
- Fill only to the upper limit mark shown by the level indicator. **Allow 25mm air gap in the tank to allow room for fuel expansion.**



### 8d. Safe Fuel Handling

DANGER: FIRE OR EXPLOSION - Petrol is highly flammable and extremely explosive. A fire or explosion can cause severe burns or death.

- Keep flammable items away while handling petrol.
- Fill fuel tank outdoors and in a well-ventilated area with the engine stopped.
- Avoid the use of open containers.
- Always wipe off spilled fuel and wait until the fuel has dried before starting the engine.
- DO NOT operate the engine with known leaks in the fuel system.
- Use proper fuel storage and handling procedures. DO NOT store fuel or other flammable materials nearby.
- Empty the fuel tank before storing or transporting this engine.
- Keep fire extinguisher handy and be prepared if a fire starts.

CAUTION: NEVER use engine or carburettor cleaner products in the fuel tank or permanent damage may occur.

- It is important to prevent gum deposits from forming in fuel system, such as the carburettor, fuel filter, fuel hose or tank during storage. Also, any alcohol-blended fuels (called gasohol, ethanol or methanol) can attract moisture, which leads to separation and formation of acids during storage.

- Acidic fuel can damage the fuel system of an engine while in storage. Be sure to review the Storage instructions.

- Petrol/Alcohol Blends: can be acidic and attract moisture and therefore are not recommended. Effects of old, stale or contaminated fuel may void your warranty.

CAUTION: To minimise gum deposits in your fuel system and to ensure easy starting, do not use fuel left over from the previous season.

## 8e. Starting the generator

The generator may be hard to start with electrical devices connected.

1. Perform the operating checklist.
2. Turn the fuel valve to the 'ON' position.
3. **Disconnect all electrical devices from the generator before starting the engine.**
4. The engine is equipped with an auto-choke.

NOTE: Choke position for starting may vary depending upon temperature and other factors. When re-starting a warm engine, the choke should be left in the HALF or OFF position.

5. Set the master switch to the run position.
6. **ELECTRIC START** - press the engine start button or use the wireless starter fob. The engine should fire in less than 5 seconds.  
**MANUAL START** - Take hold of the recoil handle and slow pull until there is a sense of resistance, and then quickly pull to start.



CAUTION: Ensure that the recoil rope is not damaged and repair if required.

Take care when manual starting in case of kickback.



If the engine fails to start after 3 attempts or stops after starting; inspect and ensure that the generator is placed on horizontal surface and check the fuel and engine oil levels.

7. Once the generator is operating stably, set the choke valve to 'OFF' position.



When connecting the generator with electrical equipment. DO NOT start or stop the engine while electrical equipment is in their 'ON' status.

There is a continual low level current draw on the battery to allow the remote wireless start etc to operate. When not in use, make sure that the starting switch is in the **OFF** position otherwise the battery voltage will drain over time.



Use of a ground fault circuit interrupter (RCD) is strongly encouraged, especially in any damp or highly conductive areas, such as metal decking or steel work.

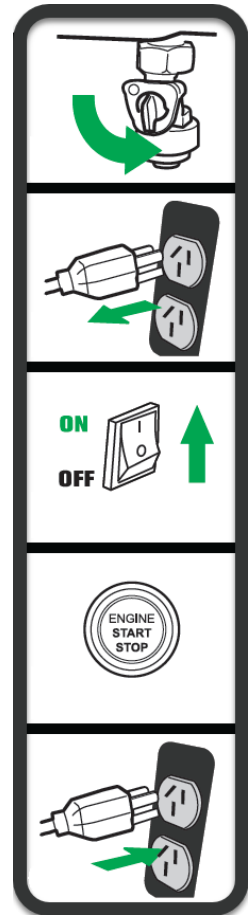

## 8f. Maximum electrical capacity

**WARNING: NEVER overload the generator. Exceeding the capacity of generator can damage the generator and/or electrical devices connected.**



All electrical devices and appliance have a power rating. Ensure your generator can supply enough rated (running) and surge (starting) watts for the electrical devices you intend to power **at the same time**.

### Calculating the Expected constant load

1. Select the electrical devices you intend to power at the same time.
2. Calculate that the total amount of power you need to run all devices and ensure it is less than the rated output of the generator.  
You may need to check the items rated (running) watts in their manuals or from the manufacturers nameplate. If the appliance, tool or motor does not give wattage, **multiply Volts times Ampere rating to determine Watts (volts x amps = watts).**

### Calculate the Surge load requirement

Devices which have an induction type electric motor i.e. garage door openers, air compressors, pumps, refrigerators, circular saws etc create additional load as they start up. **This surge current can be 3 - 5 times greater than the appliance rated size.**

i.e. Starting 'Direct on Line', a water pump rated at 750W may momentarily require a surge current equivalent to 2300W or greater.

*NOTE: Not all motors start at the same time so allow total surge watts for the largest electric motor you intend to power.*

3. Identify how many surge (starting) watts you may need.

Add the surge wattage requirement on top of the expected constant load requirement.

### AC OVERLOAD RESET

If the AC power outlet is overloaded, the circuit breaker will cut out the power to the device. If tripped remove device/load and reset switch.

## 8g. Stopping the generator



**WARNING: NEVER stop the engine with electrical devices connected and the connected devices turned 'ON'.**

1. Turn off all electrical equipment and disconnect all from the generator.
2. Allow the generator to run at no load for a few minutes to stabilize internal temperatures of the engine and generating set.
3. Press the rocker ignition switch to the 'OFF' position.
4. Turn the fuel valve to the 'OFF' position

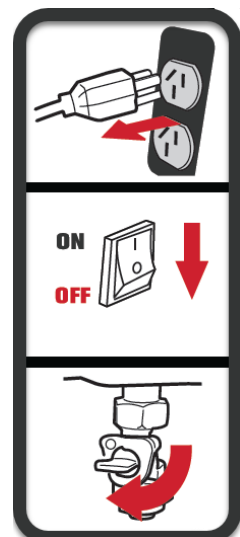



## 9. Maintenance

It is the operator's responsibility to complete all scheduled maintenance in a timely manner. Correct any issue before operating the generator. Follow the inspection and maintenance recommendations and schedules in this manual.



- Before servicing the generator, stop the generator, disconnect all electric devices and battery (if equipped) and allow the generator to cool down.



Accidental starts can cause severe injury or death. Remove and ground spark plug wire before performing any service.



Improper maintenance or failure to correct a problem before operation can cause a malfunction and result in property damage, serious injury or DEATH. Improper maintenance will void your warranty.



The filter element may contain PAHs, PAHs are harmful to your health. Please wear gloves for protection during air filter maintenance.

Follow the service intervals indicated in the chart below. Service your generator more frequently when operating in adverse conditions.

Contact your local service agent for parts or engine maintenance needs.

Engine oil	Check	Before each use
	Replace	<b>First oil change after 5 hours</b> Thereafter, every 20 hours
Air filter	Inspect / clean	Frequently
	Replace	Every 50 hours <i>or less in dusty conditions</i>
Muffler	Inspect	Every 100 hours
Spark plug	Check and adjust	Every 100 hours
	Replace	Yearly or every 300 hours
Idle speed	Inspect and adjust	Yearly or every 300 hours
Valve clearance	Inspect and adjust	Yearly or every 300 hours

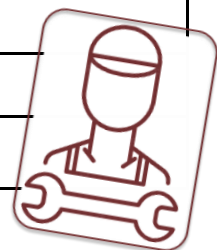

DO NOT modify the generator in any way.



The speed has been set at the factory and should not require readjustment. The generator supplies the correct rated frequency and voltage when running at factory settings. Tampering with the factory set governor will void your warranty. **NEVER** alter the governed speed.

Any unapproved adjustment will damage your engine and/or your electrical devices and void your warranty.

Consult your local authorised service agent for advice.

### 9a. Air Filter

**NEVER run the engine without the air filter, as serious damage can result.**

Regular cleaning will enhance the life of the engine.

*Remove the cover of the air filter*

*Remove the foam filter element.*

*Wash in liquid detergent and warm water.*

*Squeeze thoroughly and dry by a clean cloth.*

*Saturate in clean engine oil.*

*Squeeze in a clean, absorbent cloth to remove all excessive oil.*

*Place the filter in the assembly.*

*Refit the air filter.*



### 9b. Spark Plug



**WARNING:** Only use recommended spark plug or equivalent. Never use spark plugs that have improper heat range.

Spark plug gap: 0.6mm - 0.8mm

Spark Plug tighten Torque: 15-20 Nm (12 – 15 lb ft)

Spark Plug Model: **LG 6TC, Champion RN9YC**

Clean any dirt from the spark plug cap and spark plug base.

Remove the spark plug cap. Loosen and remove the spark plug.

Inspect the spark plug and spark plug washer. Replace if it appears damaged or worn. Clean the spark plug threads and electrode with a wire brush before replacing.

Check spark plug gap. Carefully bend side electrode to adjust the gap if necessary.

Thread the plug into the engine by hand. Once the spark plug is seated, tighten to the recommended torque the attach the spark plug cap to the plug.

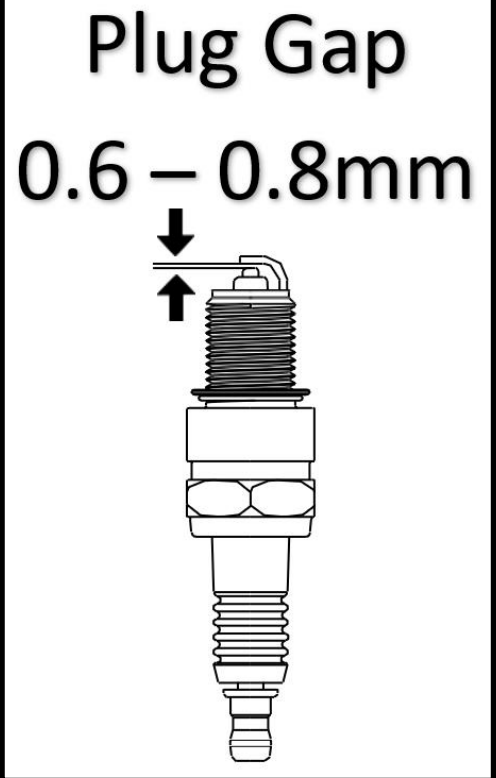

**Replace the spark plug yearly. The engine will start and run better.**

### 9c. Cleaning

Clean using damp cloths and mild cleaning agents, soft bristled brushes, vacuum or low pressure compressed air.

Avoid using running water to clean the generator.

Water can enter the alternator through its cooling slots and damage the electrical windings.



## 10. Storage and Transportation

**DANGER: FIRE OR EXPLOSION** - Gasoline is highly flammable and extremely explosive. Always shut off fuel valve before storing or transporting this generator.

**STORAGE** - The generator should be started periodically (every few weeks) and allowed to run until warm.

**LONG TERM STORAGE** - If the generator will not be used within the next 2 months or longer, we suggest the following:

- Once the Generator is cool, clean with lint free cleaning clothes and compressed air. Avoid splashing water or using aggressive solvents.

**Take care not to drive dust or other contamination into the alternator cooling slots.**

- Drain all fuel completely from the fuel hose and carburettor to prevent gum from forming.
- Turn off the fuel supply at the fuel valve.

If the storage period will be substantial, consider protection against internal corrosion by changing the oil and lubricating the engine combustion chamber.

- **Remove the spark plug and pour about 15 ml of oil into the cylinder.**
- **Use the recoil starter to crank the engine slowly to distribute the oil and lubricate the cylinder.**
- **Reattach the spark plug**

Store the unit in a clean, dry area out of direct sunlight.

**TRANSPORTATION** - To prevent fuel spillage, when transporting or during temporary storage, the generator should be secured upright in its normal operating position, with all switches in the OFF position.



# 11. Trouble Shooting Guide

**WARNING:** Turn off the generator before starting any maintenance work.  
Remove the spark plug cap and secure away from the spark plug.



Work methodically eliminating the most simple, basic and obvious potential causes first.

FAULT	POSSIBLE CAUSE	REMEDY
Engine will not start	<p>Engine switch set to 'OFF'.</p> <p>No fuel.</p> <p>Insufficient engine oil.</p> <p>No ignition.</p>	<ol style="list-style-type: none"> <li>1. Check the engine switch is in the on position</li> <li>2. Check that the fuel tap is on position</li> <li>3. Check the fuel level and if necessary fill the tank as per instructions</li> <li>4. The engine is equipped with a low oil sensor. The engine cannot be started unless the oil level is above the prescribed lower limit.</li> <li>5. Check for spark: <ul style="list-style-type: none"> <li>• Remove the spark plug cap.</li> <li>• Clean any dirt from around the plug base, then remove the spark plug.</li> <li>• Install the spark plug in the plug cap.</li> <li>• Turn the engine switch "ON".</li> <li>• Ground the spark plug thread to the motor body, pull the recoil starter to see if sparks jump across the gap.</li> <li>• If there is no spark, replace the plug.</li> </ul> </li> </ol> <p style="color: red; text-align: center;"><b>Consult a Customer Service Agent if necessary.</b></p> 
Generator has no output	<p>No power.</p> <p>Fault may be with the appliance or power cords may be faulty.</p>	<ol style="list-style-type: none"> <li>1. Reset circuit breakers / RCDs.</li> <li>2. Check any power cords for damage and continuity</li> </ol> <p>In the event of a burnt smell or signs of smoke damage consult a Customer Service Agent.</p>

## 12. Warranties – Terms and Conditions

This warranty is given in addition to the consumer guarantees found within the Australian Competition and Consumer Act 2010 (Cth) for goods purchased in Australia and the Consumer Guarantees Act 1993 NZ for goods purchased in New Zealand:



1) White International Pty Ltd / White International NZ Ltd (White International) warrant that all products distributed are free from defects in workmanship and materials, for their provided warranty period as indicated on the top or opposite side of this document. Subject to the conditions of the warranty, White International will repair any defective products free of charge at the premises of our authorised service agents throughout Australia and New Zealand if a defect in the product appears during the warranty period. If you believe that you have purchased a defective product and wish to make a claim under this warranty, contact us on our Sales Hotline on 1300 783 601, or send your claim to our postal address or fax line below and we will advise you as to how next to proceed. You will be required to supply a copy of your proof of purchase to make a claim under this warranty.

2) This warranty excludes transportation costs to and from White International or its appointed service agents and excludes defects due to non-compliance with installation instructions, neglect or misuse, inadequate protection against the elements, low voltage or use or operation for purposes other than those for which they were designed. For further information regarding the suitability of your intended application contact us on our Sales Hotline on 1300 783 601. If you make an invalid claim under this warranty, the original product will be sent back to you unrepai red.

3) This warranty refers only to products sold after the 1st January 2012, and is not transferable to another product type and only applies to the original owner, purchaser or end user, and is in addition to the consumer guarantees found within the Competition and Consumer Act 2010 (Cth) for goods purchased in Australia and the Consumer Guarantees Act 1993 (NZ) for goods purchased in New Zealand.

4) Our goods come with guarantees that cannot be excluded under the Australian Consumer Law. You are entitled to a replacement or refund for a major failure and for compensation for any other reasonably foreseeable loss or damage. You are also entitled to have the goods repaired or replaced if the goods fail to be of acceptable quality and the failure does not amount to a major failure. 2 YEAR WARRANTY.

5) To the fullest extent permitted by law, White International excludes its liability for all other conditions or warranties which would or might otherwise be implied at law. To the fullest extent permitted by law, White International's liability under this warranty and any other conditions, guarantees or warranties at law that cannot be excluded, including those in the Competition and Consumer Act 2010 (Cth), is expressly limited to: (a) in the case of products, the replacement of the product or the supply of equivalent product, the payment of the cost of replacing the product or of acquiring an equivalent product or the repair of the product or payment of the cost of having the product repaired, is at the discretion of White International or a 3rd party tribunal elected under the Competition and Consumer Act 2010 (Cth) for goods purchased in Australia and the Consumer Guarantees Act 1993 (NZ) for goods purchased in New Zealand; and

6) To the fullest extent permitted by law, this warranty supersedes all other warranties attached to the product or its packaging.

7) In the case of services, supplying the services again or the payment of the cost of having the services supplied again, is at the discretion of White International or a 3rd party tribunal elected under the Competition and Consumer Act 2010 (Cth) for goods purchased in Australia and the Consumer Guarantees Act 1993 (NZ) for goods purchased in New Zealand. 8) Our warranty commences from the date of purchase of the above mentioned pumps. Proof of purchase is required before consideration under warranty is given.

*Record your date of purchase in the space below and retain this copy for your records.*

**Date of Purchase** .....**Model Purchased** .....





**[www.whiteint.com.au](http://www.whiteint.com.au)**  
**[www.whiteint.co.nz](http://www.whiteint.co.nz)**

Please always refer to our website for further technical information & new product innovations

**Disclaimer:** Every effort has been made to publish the correct information in this manual.  
No responsibility will be taken for errors, omissions or changes in product specifications.

© 2024 Copyright White International Pty Ltd

TM ® - WARNING: Please be aware that various brands & products depicted within this document are subject to trademark, patent or design registrations. Infringement of any intellectual property contained within this document without express written authority by the appropriate intellectual property holder may result in further legal action to be taken. For any queries regarding use of the contained information please feel free to contact White International Pty Ltd.